

ZINO PRO+

《User Manual》

Version 2.0

Disclaimer & Warning

All users must read product operating instructions as well as this liability disclaimer before using any Hubsan product. By using a Hubsan product(s), users are accepting the terms and conditions of Hubsan liability and operational guidelines. This product is not suitable for minors under 14 years of age. While operating a Hubsan product(s), users also accept all liability and responsibility for their own behavior, actions as well as any consequences resulting thereof while using a Hubsan product(s). These products may only be used for purposes that are proper and in accordance with local regulations, terms and any applicable policies / guidelines Hubsan may make available. Users agree to comply with these terms and conditions, along with any and all relevant policies / guidelines set forth by Hubsan. Part of the details of this document may change with the upgrade of the product software version. Please read the upgrade details carefully before upgrading the software version. The instructions will not be notified again.

Instructions

Some product flight functions are restricted in certain areas. Once you use this product, you are deemed to have read carefully the relevant ICAO regulations, local airspace control provisions and the regulations governing UAVs. You assume all liability for any non-compliance with the foregoing, are responsible for the consequences for your actions as well as any indirect and / or direct liability that arises as a result of these limitations.

Flight environment requirements

- (1) Select an open environment devoid of high rise buildings and tall obstructions (such as trees and poles). Near buildings and obstacles, flight control signals and GPS signals can be severely weakened; GPS functions such as GPS mode and Return to Home may not function properly.
- (2) Do not fly in bad weather conditions (such as in wind, rain or fog).
- (3) Fly the aircraft in ambient temperatures of 0-40 °C.
- (4) When flying, please stay away from obstructions, crowds, high voltage lines, trees, water, etc.
- (5) To avoid remote control signal interference, do not fly in complex electromagnetic environments (such as venues with radio stations, power plants and towers).
- (6) The aircraft cannot be used in or near the Arctic circle or Antarctica.
- (7) Do not fly in no-fly zones.
- (8) Do not operate the aircraft near high pressure lines, airports or areas with severe magnetic interference.

IMPORTANT SAFETY INFORMATION

OPERATION

Be extremely careful and responsible when using the aircraft. Small electronic components can be damaged due to crashes or exposure to moisture / liquid. To avoid any injuries, do not use the aircraft with broken or damaged components.

MAINTENANCE

Do not try to open or repair the units by yourself. Please contact Hubsan or Hubsan authorized dealers for service. For more information, please visit the official website at www.hubsan.com.

BATTERY

Do not disassemble, squeeze, impact, burn, drop or trample the battery. Do not short-circuit or put the battery terminal in contact with metal. Do not expose the battery to temperatures above 60 ° C. Charge the aircraft battery prior to flight. Use a Hubsan dedicated charger for charging. Keep the battery out of the reach of children and away from any kind of moisture.

FLIGHT

Please be mindful of personal safety and the safety of others while flying.

- Do not fly in bad weather conditions.
- Do not attempt to catch the aircraft while it is in flight.
- This product is intended for experienced pilots over the age of 14.
- After every flight, completely disarm the aircraft motors and disconnect the aircraft from power. Then, you may power off the remote control.

READ THE DISCLAIMER AND SAFETY GUIDELINES FIRST BEFORE USE.

Symbol Explanation:

 Prohibited Operation

 Instruction

 Important Notice

 Explanation / Reference

USAGE ADVICE

(Hubsan has created the following operational and safety materials):

 Quick Start Guide

Hubsan Safety Advisory Notice for Intelligent battery

- If you do not plan to fly the aircraft for a long time, store the battery ~50% charged to maintain battery performance and life.
 - Please use Hubsan chargers for battery charging.
 - Discharge the battery at 5C current or below. To avoid discharge related battery damage, do not prolong the discharge time.
 - Do not charge on carpet to avoid fire.
 - Batteries need to be recharged if unused for over 3 months.
- ⊗
1. Do not disassemble or reassemble the battery.
 2. Do not short-circuit the battery.
 3. Do not use or charge near sources of heat.
 4. Do not put the battery in contact with water or any kind of liquid.
 5. Do not charge batteries under sunlight or near fire.
 6. Do not puncture or subject the battery to force of any kind.
 7. Do not throw or manhandle the battery.
 8. Never charge a battery that has been damaged, become deformed or swelled.
 9. Do not solder on or near the battery.
 10. Do not overcharge or over discharge the battery.
 11. Do not reverse charge or reverse the battery polarities.
 12. Do not connect the battery to a car charger / cigarette lighter or any kind of unconventional power source.
 13. This battery is prohibited for non-designated devices.
 14. Do not touch any kind of liquid waste or byproduct from batteries. If skin or clothes come in contact with these substances, please flush with water!
 15. Do not mix other types of batteries with lithium batteries.
 16. Do not exceed the specified charging time.
 17. Do not place the battery in a microwave or in areas of high pressure.
 18. Do not expose the battery to the sun.
 19. Do not fly in places with strong interference (high-voltage line, power stations, base stations, high-speed rail lines, signal towers, etc.)
 20. Do not use or charge in temperatures below 0 °C and above 45 °C.
 21. If a newly purchased battery is used, leaking, possesses a bad smell or other abnormalities, return immediately to the vendor.
 22. Keep away from the reach of children.
 23. Use a dedicated battery charger and follow all charging requirements.
 24. Minors who use the battery and its dedicated unit must be supervised by an adult at all times.

Contents

Important safety information		4. Flight Controller	15
Using this manual		4.1 Flight Control Mode	15
Read Before the First Flight		4.2 Flight Orientation Indicator	
1.Aircraft	04	(Single-Color Lamp)	15
1.1 Aircraft Diagram	04	4.3 Return-to-Home(RTH)	16
1.2 Aircraft battery charging	04	4.4 Search the Drone Apron	18
1.3 Aircraft battery installation	05	4.5 Intelligent Flight Mode	19
1.4 Propeller installation and disassembly	06	4.5.1 Headless Mode	19
		4.5.2 Creative video	19
2. Remote Controller	06	4.5.3 Image Tracking	20
2.1 Remote Controller Diagram	06	4.5.4 Orbiting	20
2.2 Remote Controller Features	07	4.5.5 Waypoint	20
2.3 Connecting Your Mobile Device	08	4.5.6 Line Fly Mode	21
2.4 Charging Remote Controller	08	4.5.7 Time-lapse Photography	22
2.5 Remote Controller Antenna Angle	09	4.5.8 Panorama Mode	23
2.6 Transmitter Calibration	09	4.6 Camera and Gimbal	24
		4.6.1 Camera	24
3 Flight	09	4.6.2 Camera TF Slot	24
3.1 Download the X-Hubsan App	09	4.6.3 Gimbal Pitching Axis Adjustment	25
3.2 Main Interface Guide	10	4.7 Intelligent Protection Function	
3.3 Pairing the Aircraft	10		25
3.4 Calibration	12	4.7.1 Low Power Failsafe	25
3.4.1 Horizontal calibration	12	4.7.2 Loss Of Flight Control Failsafe	
3.4.2 Compass Calibration	12		26
3.4.3 GPS Accuracy Test	13		
3.5 Staring/Stopping the Motors	14	Frequently Asked Questions	
		Parts & Accessories Diagram	
		Disclaimer Safety Guidelines	

1 Aircraft

1.1 Aircraft Diagram

1. Propeller A
2. Propeller B
3. LED indicator
4. Motor
5. Body shell
6. 4K HD Camera
7. Micro-SD/TF Slot
8. Gimbal
9. Power
10. Gimbal Protection Guard

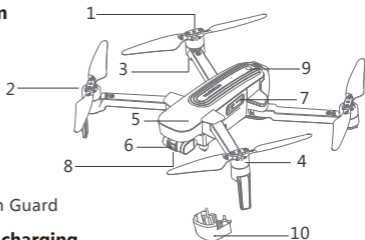

1.2 Aircraft battery charging

Aircraft Lithium Battery Capacity: 5000mAh, 11.4V lithium battery equipped with a

standard charger, charging time is about 3 hours. Charging operation: First insert the smart charging adapter into the battery, and then plug the power cord of the adapter into the "IN" interface of the charging head as shown in illustration

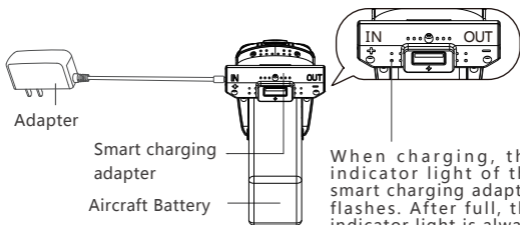
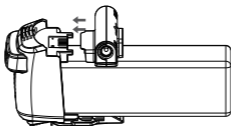

When charging, the indicator light of the smart charging adapter flashes. After full, the indicator light is always on



Note: Zino Pro+ cannot use Zino and Zino Pro batteries, otherwise it will damage the mainboard.

1.3 Aircraft battery installation

Extend the front arms first then extend the rear arms to the maximum angle. Pinch the sides of the battery and push the battery in until you hear a click. Make sure the battery is locked in. To remove the battery, hold the head of the aircraft and pinch the sides of the battery then pull the battery out.

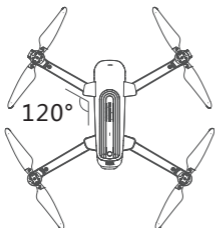

Note: To ensure the arm unfold in place

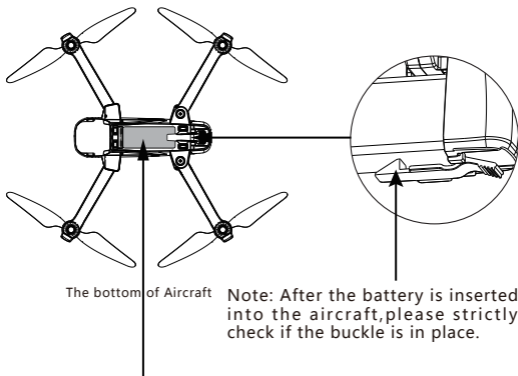

The bottom of Aircraft

Note: After the battery is inserted into the aircraft, please strictly check if the buckle is in place.

Note: To avoid sharp objects piercing the battery core. The bottom of the battery core has a glass fiber board to protect the battery core. If there are scratches or depressions on the bottom, it will not affect normal use.

1.4 Propeller installation and disassembly

Before installing the propeller, please carefully check the letters beside the aircraft motor and the letters on the propeller. The two letters must be the same when installing; When the blade is damaged or needs to be replaced, remove the screw counterclockwise to remove the propeller.

Use the only HUBSAN original Propeller, because it comes with screw glue to prevent losing propellers. (HUBSAN Standard accessories come with original screws)

HUBSAN brand new propeller screws come with screw glue (blue).

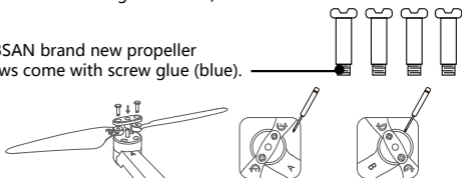

2 Remote Controller

2.1 Remote Controller Diagram

- (1). Throttle / Aileron stick
- (2). Elevator / Rudder stick
1. Throttle / Rudder Joystick
2. Elevator / Aileron Joystick
3. Return to Home (Aircraft Returns to Takeoff Point)
4. Power (Long press)
5. Auto Takeoff / Land
6. Expert / Normal Mode
7. Power Status LEDs
8. Photo
9. Video
10. Gimbal Adjustment Wheel
11. Charging / Adapter Port
12. WIFI Antenna
13. Adapter Cable

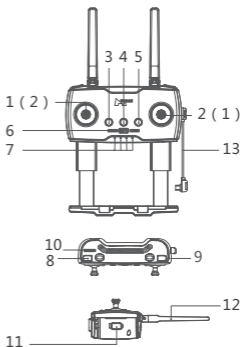

When installing the mobile device, place the device in its dedicated frame and avoid pressing the device's buttons with the frame.

2.2 Remote Controller Features

S/N	Key / Switch	Function
(1)	Throttle / Rudder Stick	Push the stick forward or backward and the quadcopter will ascend or descend (respectively). Push the stick left or right and the quadcopter will fly left or right (respectively).
(2)	Elevator / Aileron Stick	Push the stick forward or backward and the quadcopter will fly forwards or backwards (respectively). Push the stick left or right and the quadcopter will rotate counterclockwise or clockwise (respectively).
1	Throttle / Aileron Stick	Push the stick forward or backward and the quadcopter will ascend or descend (respectively). Push the stick left or right and the quadcopter will rotate counterclockwise or clockwise (respectively).
2	Elevator / Rudder Stick	Push the stick forward or backward and the quadcopter will fly forwards or backwards (respectively). Push the stick left or right and the quadcopter will fly left or right (respectively).
3	Return to Home	Long press to enter the return mode, short press to exit one button to return to the air; During the flight, the remote control "Beep... Beep..." prompt (once every three seconds) (RTH in the aircraft GPS normal and search. Can only be enabled when there are 6 or more stars)
4	Power Switch	Long press to power on or off.
5	Auto Takeoff / Land	Long Press to auto takeoff or land.
6	Normal / Sport Mode	Normal mode (left): The aircraft flies at the maximum speed set by the APP Expert mode (right): The maximum flight speed of the aircraft is 10m/s
7	Power Status LEDs	The 4 LEDs are battery indicators. Each LED represents 25% of the battery.
8	Photo	Short press to take photos.
9	Video	Long press to start recording. Short press to end recording.
10	Gimbal Adjustment	Controls the angle of the gimbal.
11	Remote control charging / patch cord interface	(1) Remote control charging interface (2) Mobile device patch cord interface

S/N	Key / Switch	Function
12	Low Battery Warning	Low battery warning for the aircraft or remote control: Remote control "Beep...Beep..." prompt (one time per second)
13	Standby protection	The remote control has no operation for 10 minutes after standby, the remote control "Beep...Beep..." Tips (once every three seconds) After 3 minutes of prompting the sound, the remote control will automatically shut down, and there will be operation within 3 minutes, and the prompt tone will stop

2.3 Connecting Your Mobile Device

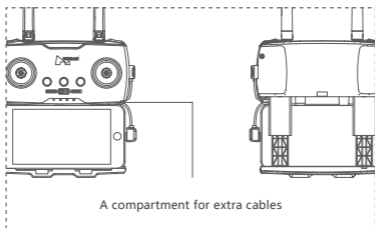

2.4 Charging Remote Controller

The remote is charged using the Micro USB cable as shown:

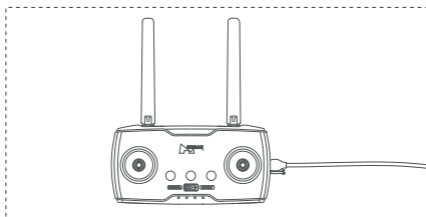

The remote control charging time is about 2.5 hours. The remote control battery indicator light flashes during charging. When charging is complete, the LEDs will be solid green.

2.5 Remote Control Antenna Angle

(1) Adjust the angle of the remote control antenna and try to face the flight direction of the aircraft as much as possible;

(2) Long-distance state, the distance between the two antennas is properly tightened to maintain the antenna directivity;

(3) Closer state, the two antennas are properly separated to maintain a wide receiving range;

(4) Do not form an occlusion or cross between the antennas.

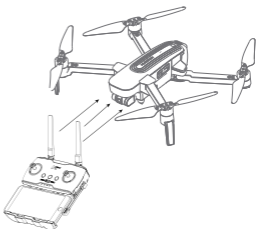

2.6 Transmitter Calibration

Enter: Push both sticks to the upper left corner and power on the transmitter simultaneously, the transmitter tips "Beep"..., which indicates enter the Calibration Mode; release the power button during calibration.

Exit: Rotate both sticks in circles to the utmost extent for three times, then release the stick, long-press any button except the power button until the remote control stops "Beep" ..., which indicates the calibration ends, the remote control automatically exit Calibration Mode.

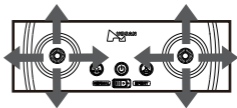
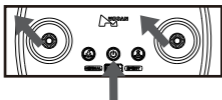

3 Flight

3.1 Download the X-Hubsan2.0 App

Before flying, users must download the X-Hubsan2.0 APP.

Download the APP for free by scanning the code on the right or by downloading it via the App Store (iOS) and Google Play (Android).



X-Hubsan 2.0

3.2 Main Interface Guide

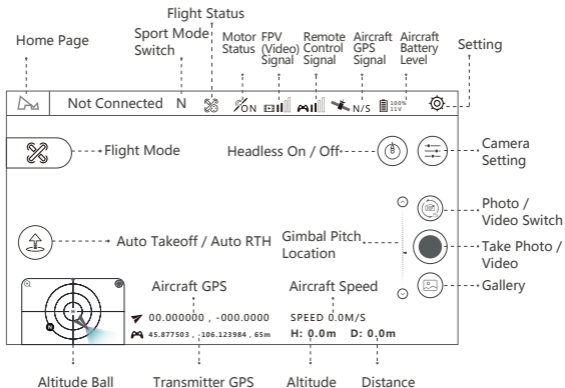

Note: This is the interface in Map mode

3.3 Pairing the Aircraft

1. Run X-Hubsan 2.0 APP, choose the aircraft model.
2. Long press the aircraft power button to turn it on.
3. Short press the transmitter power button and then turn on the transmitter, connect the transmitter to your mobile device with the RC cable.



4. Start binding (This step is only required when first binding or replace the transmitter, do it manually.)

(1) Go to APP - Setting - Controller, transmitter connection method: Synchleas

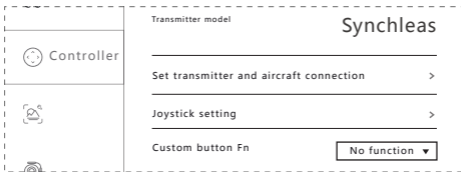

(2) Select "Set the Connection Bet ween the Transmitter and the Aircraft" to search for the aircraft.

(3) Short press the power button of the aircraft 3 times to enter binding mode.

(4) Select the detected aircraft and establish a connection.

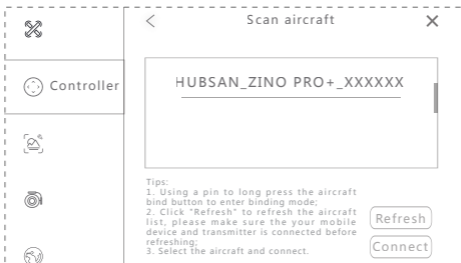

Tips :

① The binding process is completed in the factory. Generally, the user only needs to perform the first 3 steps.

② After the aircraft entered binding mode, ALL 4 LEDs flash. After the binding is completed, ALL 4 LEDs are solidly lit (Fore blue and Rear red) .

③ During binding, please keep the distance between the aircraft and the transmitter less than 1 meter.

3.4 Calibration

3.4.1 Horizontal Calibration

During the flight, when the horizontal deviation of the aircraft is found to be large, please land the aircraft and lock the motor, and place it on a level ground. After entering the APP setting interface, click "aircraft", select horizontal calibration, the aircraft will automatically calibrate, the four heading lights will flash, and after the calibration is completed, it will become steady light. Do not move the aircraft during the calibration process.

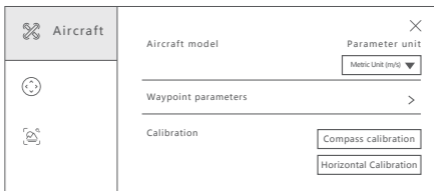

3.4.2 Compass Calibration

When using for the first time, the compass calibration will pop out before takeoff. Follow the instructions on your screen, rotate the aircraft horizontally then point the aircraft nose down and rotate it clockwise. The compass calibration message will disappear once it is completed. You must complete the compass calibration before flying the aircraft for the first time.

The compass is susceptible to interference from other electronic devices and causes abnormal flight data. Regular calibration can keep the compass in the best state, after entering the APP setting interface, Then select "Aircraft" followed by "Compass Calibration".

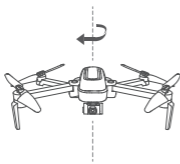

Compass 1

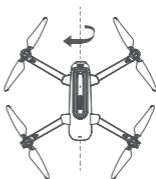

Compass 2

3.4.3 GPS Accuracy Test

After entering the APP interface, tap on "Aircraft", select "GPS Accuracy Test" then tap on "Enable / Restart GPS Accuracy Test". The aircraft will automatically proceed to test. If the GPS signal of the mobile phone or the aircraft is poor that may cause the GPS accuracy test to fail.

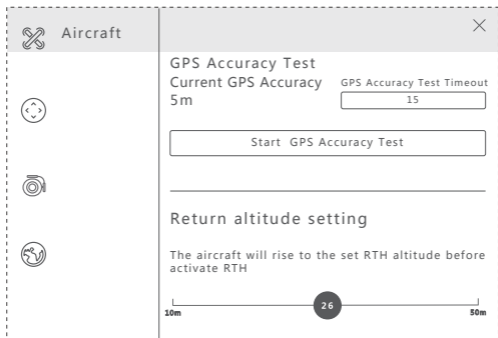

3.5 Staring/Stopping the Motors

Motor starting condition

1. The aircraft, remote control and mobile phone have been connected;
2. The aircraft has been calibrated by the compass (four Orientation LEDs are always on);
3. The aircraft must be placed horizontally.
4. It is recommended to take off when the GPS signal is ≥ 6 stars.

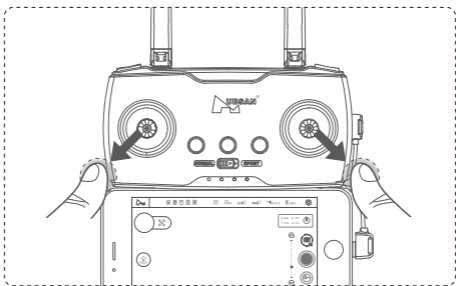

Staring the Motors

Push both stick to the bottom outer corners to start the motors. Once the motors have started spinning, Release both sticks simultaneously.

Stopping the Motors

When the motor is running, Push both stick to the bottom outer corners to stop the motors. Release both sticks once motors stop.

Fored to Stop

When flying in the air, the motor can be forced to stop in 2 seconds with outer eight bar. Use this function with caution, as it can cause the aircraft to fall and may endanger personal safety.

4 Flight Controller

4.1 Flight Control Mode

Hover mode	Hover mode works best when the GPS signal is strong.
Attitude mode	When the GPS signal is weak or the compass is disturbed, the aircraft will enter the attitude mode. In attitude mode, the aircraft will drift in the horizontal direction.
Sport mode	The maximum flight speed is 10m/s.
Normal mode	APP settings - control - maximum speed settings can be adjusted 10% - 100%, The aircraft flies at the speed set by the APP. The maximum flight speed is 8m/s.

4.2 Flight Orientation Indicator (Single-Color Lamp)

Calibration	
Power On And Start Up	All 4 LEDs flash slowly
Compass Calibration	Calibrate Compass 1: All 4 LEDs flash in cycle Calibrate Compass 2: All 4 LEDs flash in vertical pairs alternately
Horizontal Calibration	All 4 LEDs flash slowly
Flight Mode	
Flight mode	All 4 LEDs are solidly lit
Low Power	Fore / frontal blue LEDs stay solidly lit and the rear red LEDs flash rapidly

Loss Of Flight Control Indicator	The front Orientation light flashes slowly in blue, and the rear Orientation light is steady red. (When there is a conflict with low battery, priority is displayed.)
Headless Mode	Fore/front blue LEDs flash in vertical pairs alternately and rear red LEDs stay solidly
Photo	Rear red LEDs flash once
Video	Rear red LEDs flash alternately
Turn off the light	Long press the camera button.

4.3 Return-to-Home(RTH)

There are three types of RTH: One-key RTH, Low Battery RTH, and Failsafe RTH. When taking off, GPS ≥ 6 stars, the aircraft successfully recorded to the return point. If there is no GPS signal forced take-off, the position with the latest GPS ≥ 6 stars is recorded as the return point.

One-key RTH
APP one-Key RTH / remote control one-Key RTH

RTH-Process

1. Record "Home Point"
2. Trigger return conditions
3. Adjust the direction of the head
4. Return to the return altitude set by APP
 - (1) Regardless of the current height of the aircraft, if the aircraft is within 5 meters of the horizontal distance, land directly;
 - (2) If the horizontal distance is 5 meters away and within 20 meters, return at the current altitude;
 - (3) In 20 meters away, if the altitude of aircraft is more height than the return altitude, it will return directly; If no, it will rise to up to the return altitude, and then RTH;
5. Search for the drone apron during the landing process (Make sure this function is on).

Low Battery RTH

The flight controller will display a notice when a low battery warning is triggered.

The aircraft will automatically return to the Home Point if the current power is enough, otherwise it will land directly. when without GPS signal or signal is not strong that will land directly.

Performance requirements:

- (1) The appropriate low-voltage protection voltage is automatically calculated according to the altitude and distance of the flight;
- (2) After the low power forced landing or crash, if the power is lower than 10%, enter the protection mode: turn off the picture transmission, but save normal data communication.

Failsafe RTH

When the aircraft loses connection with the remote control for more than 5 seconds, the aircraft automatically returns or land directly.

Performance requirements:

- (1) After the aircraft loses control for 5 seconds, it triggers automatic return;
- (2) If the connection is restored during the return flight, the return flight can be cancelled;
- (3) Landing directly when there is no GPS signal or the signal is not strong.

4.4 Search the Drone Apron

When the aircraft landed or returned to a height of about 10 meters from the ground, it will automatically enter the search for the drone apron function.

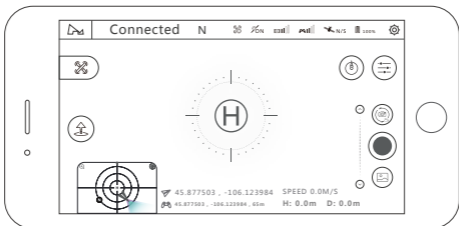

(1) The gimbal overlooks the search for the drone apron [H], Apron requirements: 1 Sharp contrast, 2 white "H" lettering, 3 Apron without obstruction.

(2) The aircraft will first pan to the top of the apron and lock the apron, then descend smoothly after successful recognition. When landing to a height of less than 3 meters, the aircraft pan/tilt will resume normal view and no longer adjust the position of the aircraft and land directly. If an error is identified or other unexpected circumstances occur, press the stop button to exit the function.

(3) If the aircraft has not been found to the apron or critical low battery when it has landed 5 meters, the aircraft will land directly.

(4) The search for the drone apron function cannot be performed in video mode.

(5) If needn't, please turn it off in the settings.

4.5 Intelligent Flight Mode

4.5.1 Headless Mode

Record a flight path , the direction of the nose is the direction of advance , the heading and forward direction of the aircraft are independent of the direction of the nose during flight.

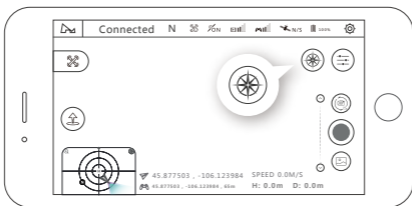

4.5.2 Creative video

360° Photography:

- (1) Select the direction of rotation (clockwise / counterclockwise);
- (2) Set the rotation angle, the range of rotation angle (90° - 360° , accuracy 1°);
- (3) Set the speed (2 - 30° / sec, accuracy 1);
- (4) Click GO, the aircraft rotates in place in the hover position, shooting during the rotation + storage

Video recording

- (5) During the execution, you can click the exit button to exit the mode and save the video;

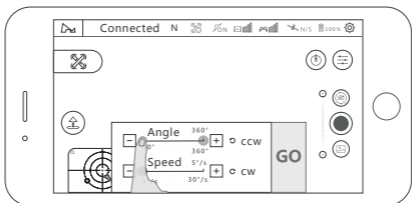

4.5.3 Image Tracking

Select the target on the APP. After the selecting successfully, tap on "Go" and the aircraft will follow the movements of the target. The range of tracking altitude and distance is 5-15 meters.

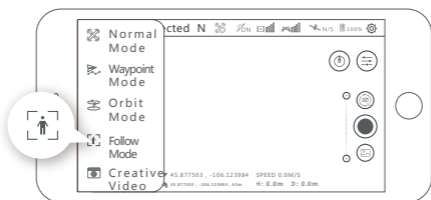

4.5.4 Orbiting

Tap on "Mode Selection" then "Orbit Mode" to set the current location or the position of the mobile device as the center. During Orbit mode, you can adjust the speed and direction by moving the control stick left and right and adjust the orbit radius by moving the control stick forward and backward.

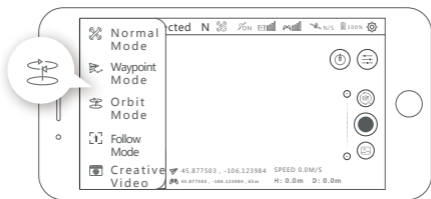

4.5.5 Waypoint

The aircraft will fly along the flight path drawn on-screen or saved, you can adjust the speed of the aircraft during flight .

Waypoint Planning: You can preset the waypoint parameters such as the number of waypoints, the altitude of each waypoints and other parameters. The aircraft will follow the preset parameters after you activate waypoint mode. You can control the flying speed during flight or you can pause or resume the Waypoint mode.

Waypoint Memory: After entering the mode, fly the aircraft and tap on "Memorize Waypoints" on the APP and the aircraft will mark the location. After memorizing all the waypoints, upload and execute, then the aircraft will fly according to the memory.

If the aircraft is not in the starting position, the aircraft will fly to the starting position before starting this function.

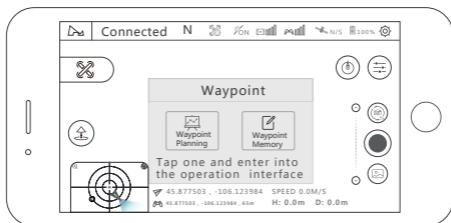

4.5.6 Line Fly Mode

Tap on "Mode Selection" then "Line Fly Mode". Set the angle, distance and speed of the aircraft.

Performance requirements:

1. Set the angle (0 ~ 360 °, accuracy 1 °);

Set the distance (10-100 meters, accuracy 1 meter); set the speed (1-8 m / s, accuracy 0.1);

2. Once setup is complete, the aircraft will execute Line Fly mode. During the flight, pilots can take photos or videos manually, or pause / resume / stop the flight at any time.

During the flight, the throttle stick is controllable and the other directions are uncontrollable;

3. You can pause/resume/stop the flight at any time.
4. When the aircraft is low on battery or lost connection, the aircraft will always set Return to Home as the priority mission.

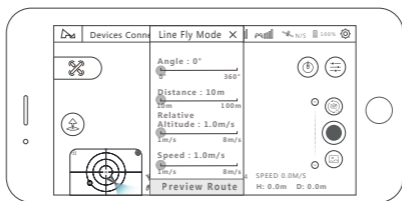

4.5.7 Time-lapse Photography

When you choose time compressor mode, you can choose free time-lapse and surround time-lapse.

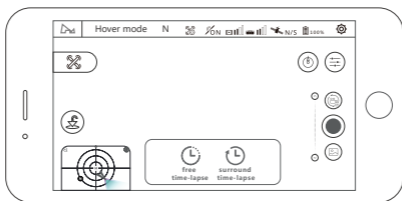

Free Time-lapse

The aircraft will take a certain number of photos and compose time-lapse videos automatically according to the parameters which you set. During the process of shooting, the user can control the flight of the aircraft freely.

- (1) choose free time-lapse;
- (2) set the shutter interval taken by the aircraft, the time of video generated and the maximum flight speed;
- (3) after done, please click 'GO' and start shooting.

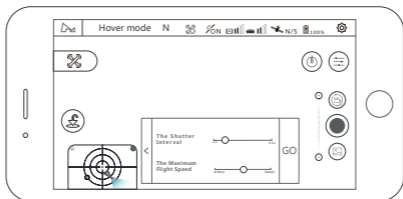

Circle Time-lapse

The aircraft will take a certain number of photos and compose time-lapse video automatically according to the circle point of interest and the parameters which you set. During shooting, operating lever will automatically quit the task.

- (1) select surround time-lapse
- (2) Set the shutter interval for aircraft ,Maximum flight speed and orbiting radius;
- (3) set the circle direction, and position the circle center by adjusting the circle radius and the direction of the aircraft nose
- (4) after done, please click 'GO' and start shooting.

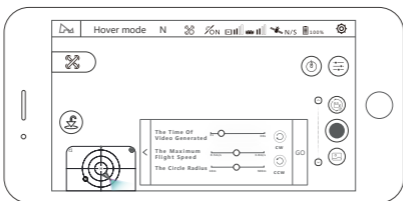

4.5.8 Panorama mode

In the panoramic mode, you can choose spherical, 180°, vertical shooting and wide angle shooting.

In this mode, the aircraft will perform the shooting task automatically. After the shooting done, you can view photos and videos from the TF card, also export photos and videos and composite it. During shooting, the user will quit the task automatically.

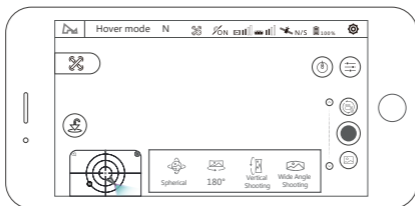

4.6 Camera and Gimbal

4.6.1 Camera

Use this APP to set the video resolution, white balance, colour, etc, as shown APP.

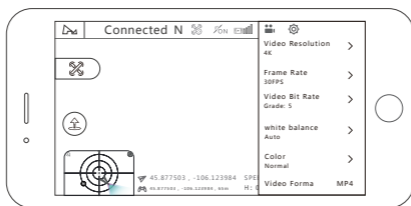

4.6.2 Camera TF Slot

1. Support TF card, U1 or Class10 and above 16G/32G/64G/128G;
2. Support hot swap, it is recommended to plug in the TF card after turning off the power asap;
3. The maximum recording time is up to 30 minutes.

4.6.3 Gimbal Pitching Axis Adjustment

APP Adjustment

Method 1: Long press the blank space in the video preview interface, the mobile device should vibrate once and the icon (1) should appear by your finger then you can move your finger up and down on the screen to adjust the pitching axis.

Method 2: Click the up and down adjustment buttons of the gimbal pitching axis slider to tune the pitching axis.

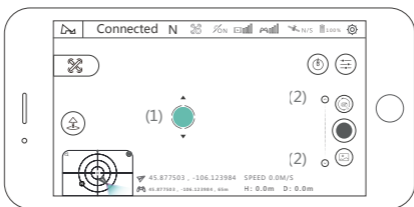

Transmitter Adjustment

Adjust the gimbal pitching slider on the transmitter to adjust the angle of the gimbal.

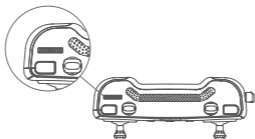

4.7 Intelligent Protection Function

4.7.1 Low Power Failsafe

When the aircraft battery is low, there is likely insufficient power to support the return of the aircraft. Please land the aircraft immediately, otherwise the aircraft will fall and cause damage to the aircraft and surrounding objects. To prevent this, the aircraft flight control will use flight information to determine whether to perform a Return to Home or to land immediately.

4.7.2 Loss of Flight Control Failsafe

When the flight control connection between the aircraft and transmitter is lost, the aircraft will automatically land or return to where the remote control / transmitter was last located and land there. This can drastically reduce the possibility of the aircraft crashing or being lost.

Conditions that may trigger a failsafe:

- 1) Transmitter is powered off / loses power.
- 2) The flight distance exceeds the remote control's signal transmission range.
- 3) There is an obstacle between the remote control and aircraft.
- 4) The flight control or transmitter signal is interrupted by strong external electronic interference.

⊘ To ensure the successful return of the aircraft if it loses flight control connection, users must confirm that the aircraft has enough GPS satellites to fly safely in GPS mode. Users must also be certain that the flight environment is clear enough for an emergency return and landing.

If the aircraft's GPS satellites drop below 6 for more than 20 seconds while the X4 is returning to Home Point, the aircraft will automatically descend.

Frequently Asked Questions

1. Aircraft and remote control are not pairing

- (1) Check if the status of the APP control signal icon changes.
- (2) Android phone requires USB settings, please check the "Connecting Tutorial for Android Phones"

2. Aircraft can't be searched

- (1) Restart the aircraft, remote control and x-hubsan 2 APP.
- (2) Update aircraft firmware.
- (3) Check if the position of the TF card slot in the fuselage is steady red. If it flashes that is abnormal.

3. Figure transmission or easy to lose control of the broken connection

- (1) Adjust the antenna Angle on the aircraft, do not block in the middle.
- (2) Change the flight site, please do not fly in tall buildings, or near signal tower.
- (3) Update the latest firmware of the aircraft.

4. The aircraft is hovering unsteadily

(1) Change the flight site, please do not fly near tall buildings and signal towers.

(2) The aircraft compass calibration and Horizontal calibration.

(3) Whether the wind is too strong to affect the flight.

5. Aircraft GPS accuracy is not accurate or cannot pass GPS accuracy test. The GPS accuracy of the aircraft is inaccurate or cannot pass the GPS accuracy test

(1) Search for GPS 6 or more in outdoor open spaces

(2) Surround the aircraft to walk around

(3) Replacing your mobile device

6. Battery cannot be charged

Replug the charger and battery.

7. Flight time is irregular

If the battery is overcharged or overheated or the high temperature environment is likely to decrease the battery life, it is recommended that the battery be stored at the remaining 50% or not.

8. Gimbal's angle of inclination is too large or gimbal error

(1) Restart the aircraft for Gimbal calibration

(2) APP Check if the status of the gimbal is normal

9. Failed to open the gimbal

Please remove the Gimbal protective cover and then turn it on before starting.

10. Low quality images.

(1) Check if the lens protector is torn off

(2) Use in a well-lit environment

(3) Set the shooting parameters in the APP camera settings

(4) The captured video source file is saved in the TF card with the AA file.

11. Gimbal wet

(1) Flying in heavy fog or clouds may make the gimbal wet, change the aircraft storage location.

(2) Place the desiccant in the protective cover of the gimbal when stored.

12. Pictures or Video loss

(1) Remember to press the end button after completing the video recording, otherwise it may cause video damage or loss.

(2) Check if the TF card is bad

Limitation of Liability

Hubsan accepts no liability for damages, injuries or any legal responsibilities incurred directly or indirectly from the use of Hubsan products under the following conditions:

1. Damages, injuries or any legal responsibilities incurred when users are drunk, under the influence of drugs or anesthesia, dizzy, fatigued, nauseous and / or affected by other conditions both physical and mental that could impair sound judgment and / or personal ability.

2. Subjective misjudgment and / or intentional mis-operation of products.

3. Any and all mental damage, trauma, impairment, illness, compensation caused / solicited by accidents involving Hubsan products.

4. Product operation in no-fly zones (i.e. natural reserves).

5. Malfunctions or problems caused by modification, refit, replacement or use with non-Hubsan accessories / parts, failure to follow the guidance of the manual in assembly or operation.

6. Damages, injuries or any legal responsibilities caused by mechanical failures due to natural wear and tear (aircraft flight time clocking in 100 hours or above), corrosion, aging hardware, etc.

7. Continued flight after low voltage protection alarms are triggered.

8. Knowingly flying aircraft under abnormal conditions (such as when water, oil, soil, sand or other unknown material are inside the X4, the aircraft and / or transmitter are incompletely assembled, the main components have obvious faults, obvious defect or missing accessories, etc).

9. Flying in the following situations and / or environments: areas with magnetic interference (such as high voltage lines, power stations, broadcasting towers and mobile base stations), radio interference, government regulated no-fly zones, if the pilot loses sight of the X4, suffers from poor eyesight or is otherwise unsuited for operating Hubsan products.

10. Aircraft use in or exposure to bad weather, such as a rain, wind, snow, hail, lightning, tornadoes and hurricanes.

11. Products are involved in / exposed to collisions, fire, explosions, floods, tsunamis, manmade and / or natural structure collapses, ice, avalanches, debris, landslides, earthquakes, etc.

12. The acquisition, through use of Hubsan products (specifically but not limited to aircraft), of any data, audio, video that results in infringement of law and / or rights.

13. Misuse and / or alteration of batteries, product / aircraft circuits, hardware protections (including protection circuits), RC model and battery chargers.

14. Any malfunction of equipment or accessory, including memory cards, that results in the failure of an image or video to be recorded or to be recorded in a way that is machine readable.

15. Users who engage in reckless, unsafe flying (with or without sufficient training).

16. Non compliance with pre cautions, instructions, information and operation guidelines / methods given through official Hubsan website announcements, product quick start guides, user manuals, etc.

17. Other losses, damages, or injuries that are not within the boundaries of Hubsan responsibility.

RISK OF EXPLOSION IF BATTERY IS REPLACED BY AN INCORRECT TYPE.

DISPOSE OF USED BATTERIES ACCORDING TO THE LOCAL REGULATIONS.

HAZARDOUS MOVING PARTS KEEP FINGERS AND OTHER BODY PARTS AWAY.

Declaration of Conformity

Hereby, SHENZHEN HUBSAN TECHNOLOGY CO., LTD., declares this product is in compliance with the essential requirements and other relevant

provisions of Directive 2014 / 53 / EU. A copy of the original Declaration of Conformity can be obtained at the following address: 13th Floor, Bldg 1C, SHENZHEN NANSHAN SOFTWARE INDUSTRY BASE, Xuefu Road, Nanshan District, Shenzhen, China

This product bears the selective sorting symbol for waste electrical and electronic equipment (WEEE). This means that this product must be handled pursuant to European Directive 2012 / 19 / EU in order to be recycled or dismantled to minimize its impact on the environment.

For further information, please contact your local or regional authorities. Electronic products not included in the selective sorting process are potentially dangerous for the environment and human health due to the presence of hazardous substances.

FCC INFORMATION

This equipment has been tested and found to comply with the limits for a Class B digital device, pursuant to Part 15 of the FCC Rules. These limits are designed to provide reasonable protection against harmful interference in a residential installation. This equipment generates, uses, and can radiate radio frequency energy and, if not installed and used in accordance with the instructions, may cause harmful interference to radio communications. However, there is no guarantee that interference will not occur in a particular installation. If this equipment does cause harmful interference to radio or television reception, which can be determined by turning the equipment off and on, the user is encouraged to try to correct the interference by one or more of the following measures:

- Reorient or relocate the receiving antenna.
- Connect the equipment into an outlet on a circuit different from that to which the receiver is connected.
- Consult the local dealer or an experienced radio / TV technician for help.

Changes or modifications not expressly approved by the party responsible for compliance could void the user's authority to operate the equipment.

This device complies with Part 15 of the FCC Rules. Operation is subject to the following two conditions: (1) this device may not cause harmful interference, and (2) this device must accept any interference received, including interference that may cause undesired operation.

Electrical and electronic equipment that are supplied with batteries (including internal batteries)

WEEE Directive & Product Disposal

At the end of its serviceable life, this product should not be treated as household or general waste. It should be handed over to the applicable collection point for the recycling of electrical and electronic equipment, or returned to the supplier for disposal. Internal / Supplied Batteries.

This symbol on the battery indicates that the battery is to be collected separately. This battery is designed for separate collection at an appropriate collection point.



Please read the operating instructions carefully before use!



Flight Academy

- Never leave units unattended when charging
- Unplug the charging cable immediately after charging
- Propellers may cause injury
- This product is not a toy
- Not suitable for children under 14 years of age

Product name: ZINO PRO+

Product Standard Number: Q / HBS 001-2017

Vendor: Shenzhen Hubsan Technology Co., Ltd

Address: Unit 2801-2802A, Building F, Xinghe WORLD ,
Yabao Road, Bantian Street, Longgang District, Shenzhen

Email: service@hubsan.com

WWW.HUBSAN.COM